

HF7520

SUBMINIATURE POWER RELAY



File No.: E133481



File No.: R50351269



File No.: CQC09002034524

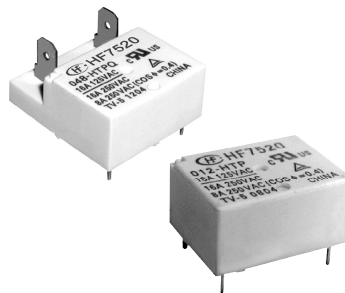

Features

- High rating: 16A,
- TV-5 load capability
- High sensitive: 200mW
- Low height, flat construction
- PCB & QC layouts available
- Plastic sealed and flux proofed types (with vent-hole cover) available
- UL insulation system: Class F
- Product in accordance to EN 60335-1 available

RoHS compliant

CONTACT DATA

Arrangement	1C	1A
Contact resistance ¹⁾	100mΩ max.(at 1A 6VDC)	
Contact material	See ordering info.	
Contact rating (Res. load)	NO: 10A 125/250VAC	Standard type: TV-5 10A 30VDC 10A 125/250VAC
	NC: 6A 125/250VAC	High capacity type: TV-5 16A 30VDC 16A 125/250VAC 8A 250VAC(COSØ=0.4)
Max.switching voltage	250VAC	250VAC/30VDC
Max.switching current	NO:10A NC: 6A	16A
Max.switching power	NO: 2500VA NC: 1500VA	4000VA/480W
Mechanical endurance	1 x 10 ⁷ OPS	
Electrical endurance	HP type: 5 x 10 ⁴ ops (16A 250VAC, Resistive load, Room temp., 1s on 9s off)	
	H type: 5 x 10 ⁴ ops (10A 250VAC, Resistive load, Room temp., 1s on 9s off)	
Electrical endurance	Z type: 5 x 10 ⁴ ops (NO, 10A 250VAC, Resistive load, Room temp., 1s on 9s off)	
	Z type: 5 x 10 ⁴ ops (NC, 6A 250VAC, Resistive load, Room temp., 1s on 9s off)	

Notes:1) The data shown above are initial values.
2) For plastic sealed type, the venting-hole should be opened in electrical endurance test.

COIL

Coil power	1 Form A: Approx. 200mW; 1 Form C: Approx. 400mW
------------	-----------------------------------------------------

CHARACTERISTICS

Insulation resistance	1000MΩ (at 500VDC)	
Dielectric strength	Between coil & contacts	2500VAC 1 min
	Between open contacts	1000VAC 1 min
Operate time (at rated.volt)	15ms max.	
Release time (at rated.volt)	5ms max.	
Shock resistance	Functional	98m/s ²
	Destructive	980m/s ²
Vibration resistance	10Hz to 55Hz 1.5mm DA	
Humidity	5% to 85% RH	
Ambient operating temperature	-40°C to 105°C	
Termination	1C: PCB	
	1A: PCB & QC	
Unit weight	PCB: Approx.9g	
	QC: Approx.10.5g	
Construction	Plastic sealed, Flux proofed	

Notes: 1) The data shown above are initial values.
2) Please find coil temperature curve in the characteristic curves below.

SAFETY APPROVAL RATINGS

UL/CUL	1 Form A	TV-5 125VAC 16A 125VAC at 85°C 10A 250VAC at 85°C 16A 30VDC at 85°C 0.3A 110VDC at 85°C 13A 125VAC at 105°C 10A 250VAC at 105°C
	1 Form C	NO: 10A 250VAC NC: 6A 250VAC
TÜV	1 Form A	16A 250VAC 10A 30VDC 8A 250VAC (COSØ=0.4)

Notes: 1) All values unspecified are at room temperature.
2) Only typical loads are listed above. Other load specifications can be available upon request.



HONGFA RELAY

ISO9001, ISO/TS16949, ISO14001, OHSAS18001, IECQ QC 080000 CERTIFIED

2020 Rev. 1.00

COIL DATA

at 23°C

1 Form C type

Nominal Voltage VDC	Pick-up Voltage VDC max. ¹⁾	Drop-out Voltage VDC min. ¹⁾	Max. Voltage VDC ^{*2)}	Coil Resistance Ω
5	4.0	0.5	6.5	62.5 x (1±10%)
6	4.8	0.6	7.8	90 x (1±10%)
9	7.2	0.9	11.7	202.5 x (1±10%)
12	9.6	1.2	15.6	360 x (1±10%)
18	14.4	1.8	23.4	810 x (1±10%)
24	19.2	2.4	31.2	1440 x (1±10%)
48	38.4	4.8	62.4	5760 x (1±10%)

1 Form A type

Nominal Voltage VDC	Pick-up Voltage VDC max. ¹⁾	Drop-out Voltage VDC min. ¹⁾	Max. Voltage VDC ^{*2)}	Coil Resistance Ω
5	4.0	0.5	6.5	125 x (1±10%)
6	4.8	0.6	7.8	180 x (1±10%)
9	7.2	0.9	11.7	405 x (1±10%)
12	9.6	1.2	15.6	720 x (1±10%)
18	14.4	1.8	23.4	1620 x (1±10%)
24	19.2	2.4	31.2	2880 x (1±10%)
48	38.4	4.8	62.4	11520 x (1±10%)

Notes:1) The data shown above are initial values.

2)*Maximum voltage refers to the maximum voltage which relay coil could endure in a short period of time.

ORDERING INFORMATION

Type	HF7520 / 012 -H S T P Q (XXX)
Coil voltage	5, 6, 9, 12, 18, 24, 48VDC
Contact arrangement	H: 1 Form A Z: 1 Form C
Construction ¹⁾	S: Plastic sealed Nil: Flux proofed
Contact material	T: AgSnO ₂ Nil: AgCdO (Only for 1 Form A) AgNi (Only for 1 Form C)
Contact capacity	P: High Capacity type (Only for 1 Form A) Nil: Standard type
Terminal type	Q: QC (Only for 1 Form A and high capacity type) Nil: PCB
Special code ⁴⁾	XXX: Customer special requirement Nil: Standard

Notes: 1) We recommend flux proofed types for a clean environment (free from contaminations like H₂S, SO₂, NO₂, dust, etc.).

We suggest to choose plastic sealed types and validate it in real application for an unclean environment (with contaminations like H₂S, SO₂, NO₂, dust, etc.).

- Contact is recommended for suitable condition and specifications if water cleaning or surface process is involved in assembling relays on PCB.
- When the ambient temperature reaches 105°C degree or more, please select flux proofed and high capacity type. Besides, please indicate the exact ambient temperature when ordering.
- The customer special requirement express as special code after evaluating by Hongfa.

OUTLINE DIMENSIONS , WIRING DIAGRAM AND PC BOARD LAYOUT

Unit: mm

1 Form A (PCB)

Outline Dimensions

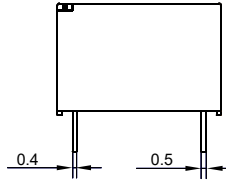
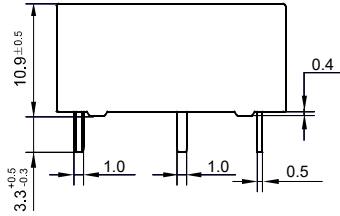

Wiring Diagram (Bottom View)

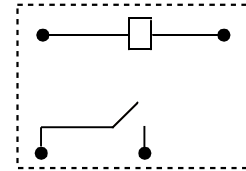

PCB Layout (Bottom view)

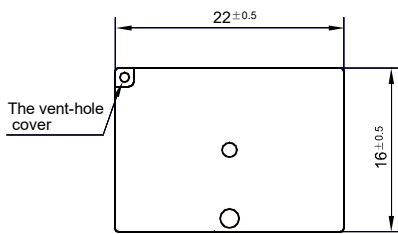

(Top view)

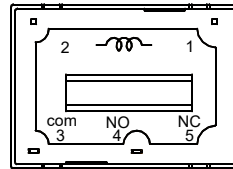

(Bottom View)

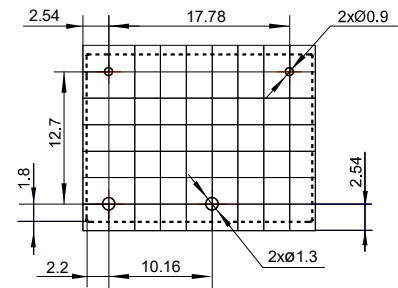

1 Form A (Wide terminal)

Outline Dimensions

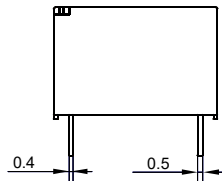
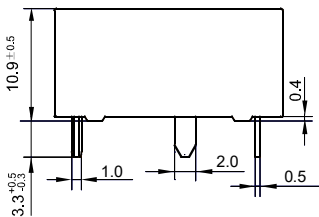

Wiring Diagram

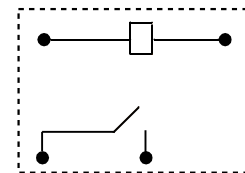

PCB Layout (Bottom view)

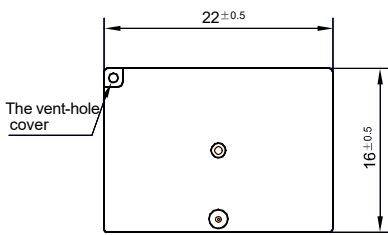

(Top view)

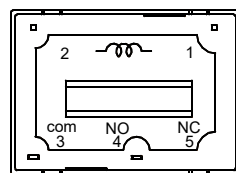

(Bottom View)

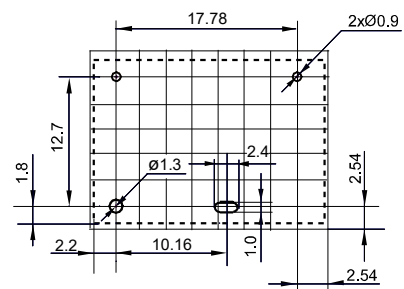

OUTLINE DIMENSIONS , WIRING DIAGRAM AND PC BOARD LAYOUT

Unit: mm

1 Form A (QC)

Outline Dimensions

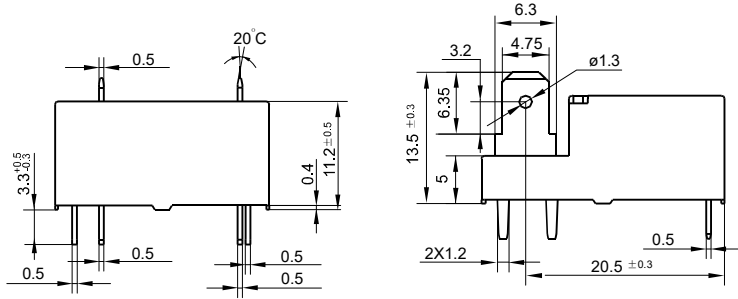

Wiring Diagram

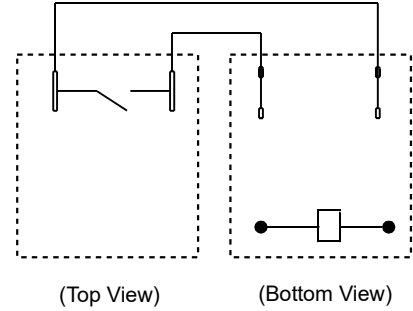

PCB Layout (Bottom view)

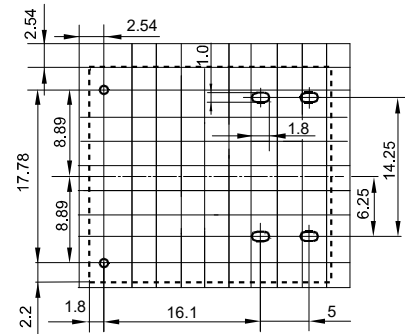
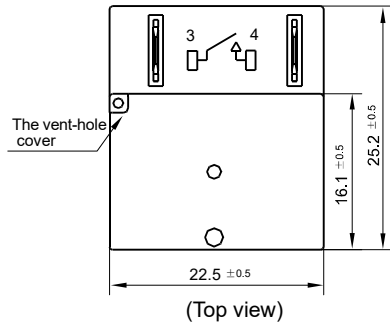

1 Form C (PCB)

Outline Dimensions

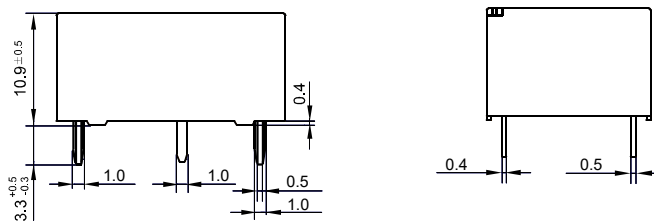

Wiring Diagram (Bottom View)

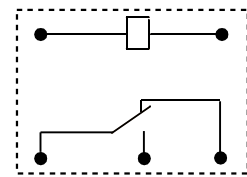

PCB Layout (Bottom view)

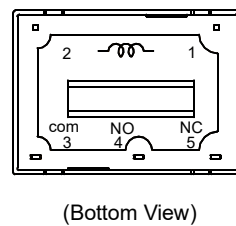
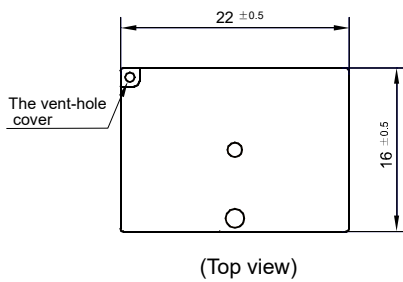

Remark: 1) In case of no tolerance shown in outline dimension: outline dimension $\leq 1\text{mm}$, tolerance should be $\pm 0.2\text{mm}$; outline dimension $> 1\text{mm}$ and $\leq 5\text{mm}$, tolerance should be $\pm 0.3\text{mm}$; outline dimension $> 5\text{mm}$, tolerance should be $\pm 0.4\text{mm}$.
 2) The tolerance without indicating for PCB layout is always $\pm 0.1\text{mm}$.

CHARACTERISTIC CURVES

MAXIMUM SWITCHING POWER

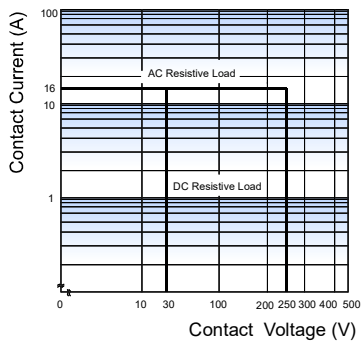

ENDURANCE CURVE

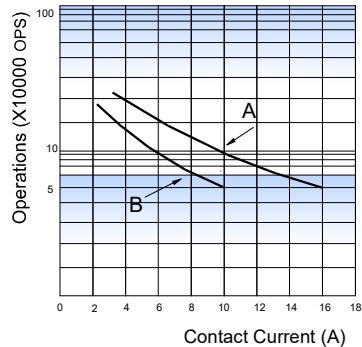

COIL TEMPERATURE RISE

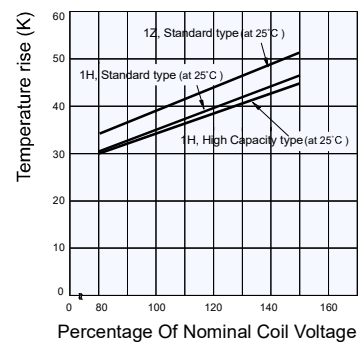

Notes:

- (1) Curve A: HP type
Curve B: H type
- (2) Test conditions:
Curve A: 16A 250VAC, Resistive load, Room temp., 1s on 9s off
Curve B: 10A 250VAC, Resistive load, Room temp., 1s on 9s off

Disclaimer

The specification is for reference only. See to "Terminology and Guidelines" for more information. Specifications subject to change without notice. We could not evaluate all the performance and all the parameters for every possible application. Thus the user should be in a right position to choose the suitable product for their own application. If there is any query, please contact Hongfa for the technical service. However, it is the user's responsibility to determine which product should be used only.

© Xiamen Hongfa Electroacoustic Co., Ltd. All rights of Hongfa are reserved.